

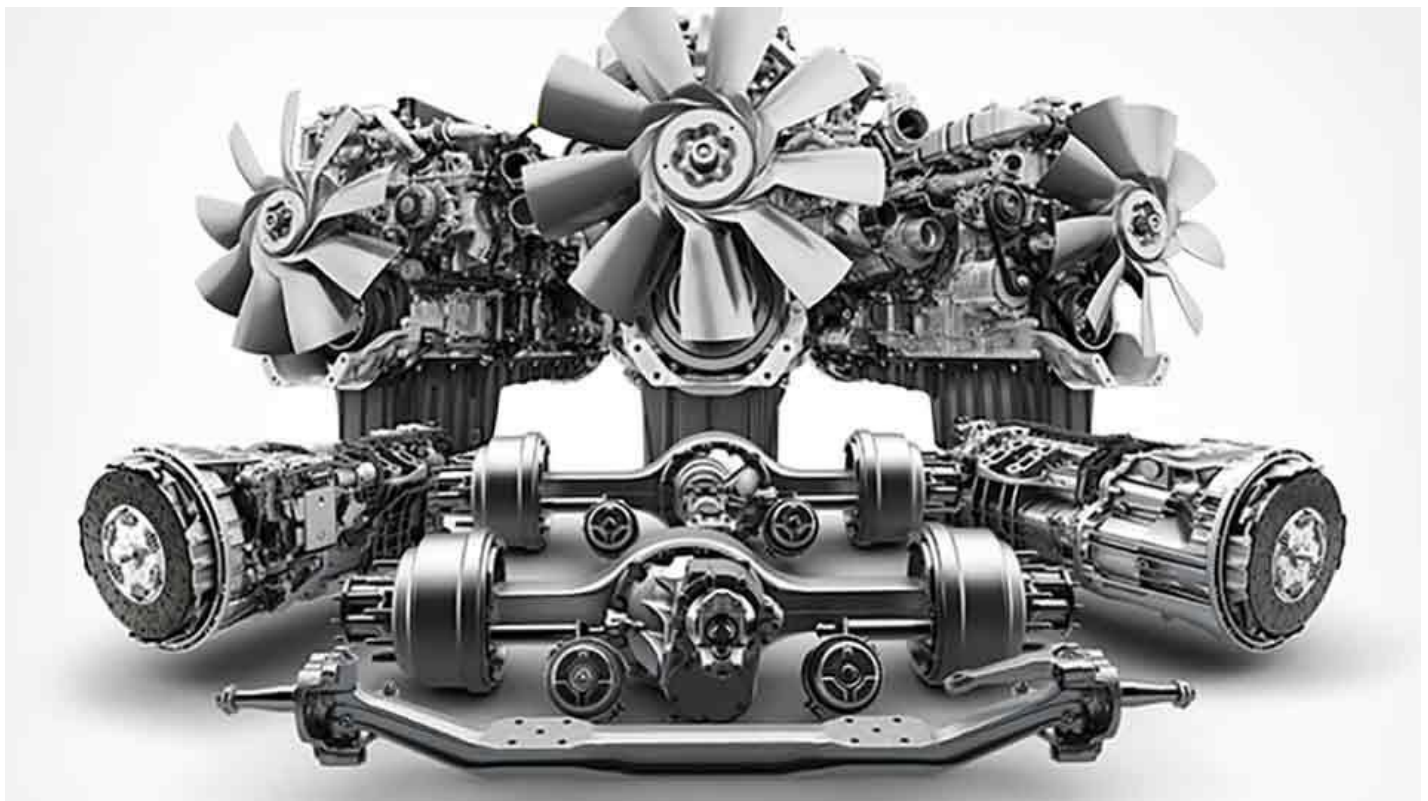

TRUCK, TRAILER, AND AUTOMOTIVE PARTS

PRODUCT CATALOGUE



TRAILER RUBBER ROLLERS

<p>Boat Trailer Keel Rollers</p>	
<p>Trailer Y-Stops</p>	
<p>Trailer Spool Rollers</p>	
<p>Trailer Bow Rollers</p>	

RUBBER MUD FLAPS / GUMMI SPRITZSCHUTZ

Our range of Rubber Mats is used in automotive interior part to avoid heavy dust. In this particular range, we also offer customized solutions and deliver a range of mats as per customer requirement and specification. We make use of high grade raw material to manufacture these mats to crown it with the properties of resistance to cuts and general wear & tear. These mats are appreciated by clients for their durability and minimal maintenance cost.



RUBBER WHEELS

In this particular range, we offer customized solutions. Available with Steel Pipe inserted. Diameter, width, etc, can be customized as per customer specifications.



BUDGET LOCK / DOOR LATCH

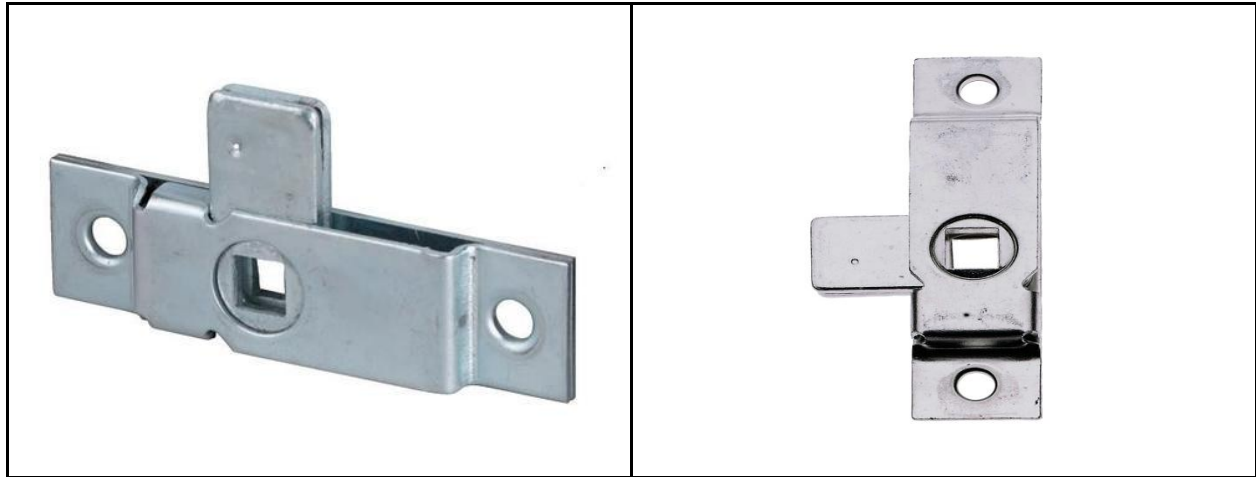

RUBBER FLOOR MATS / GUMMI FUSSMATTE



WHEEL STOPPER WEDGE DIN76051

A	B	C	H	R	Désignation	Type
120	100	210	160	384	120 / DIN 76051	NG 36
160	135	250	195	431	160 / DIN 76051	NG 46
200	160	310	235	550	200 / DIN 76051	NG 53

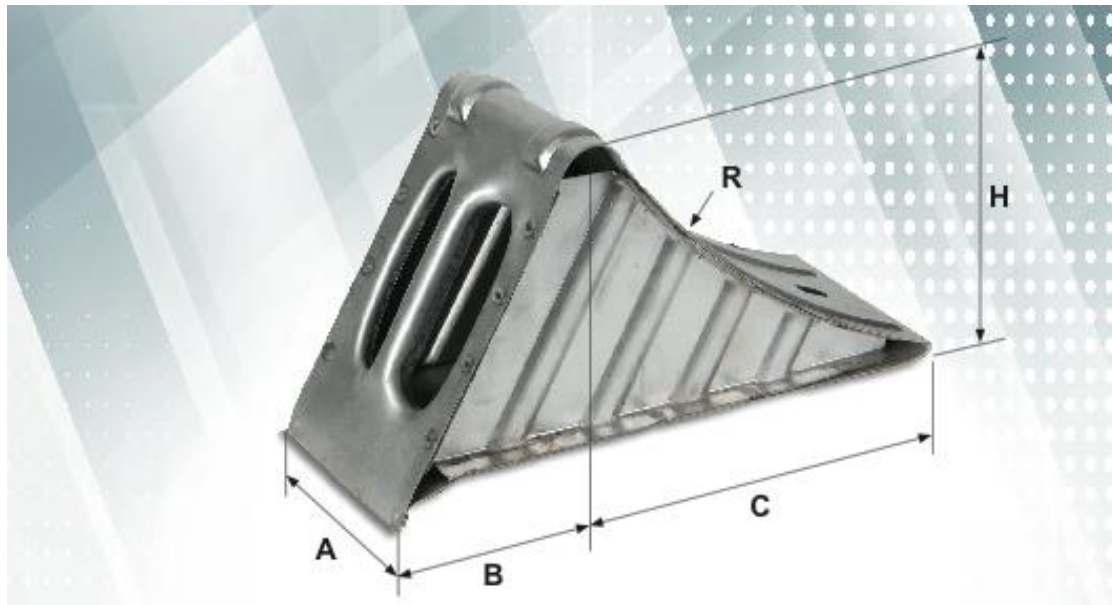

CHECK CABLES

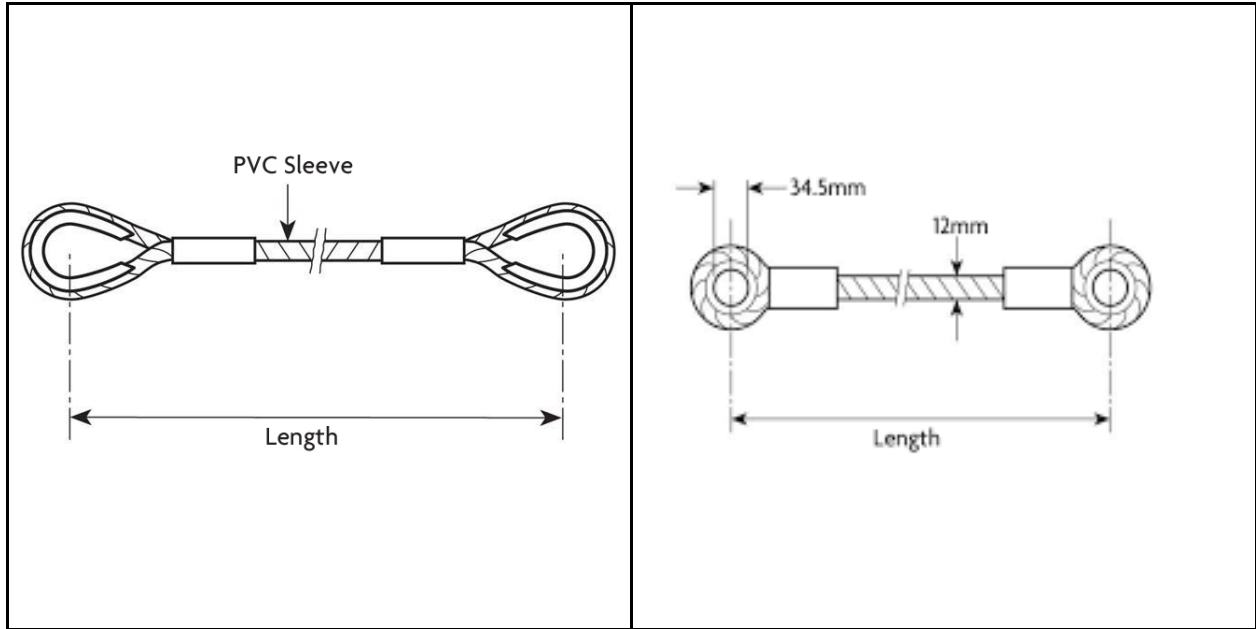

HEIGHT LIMITING SPRING

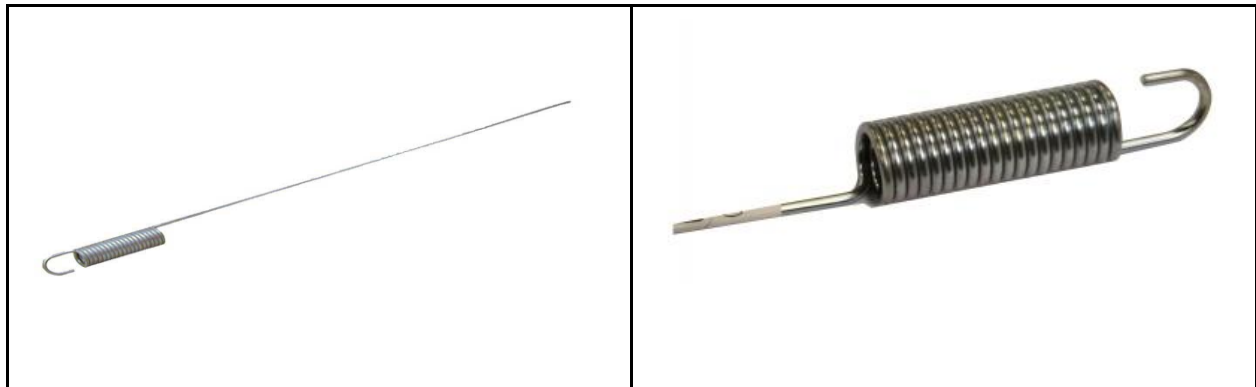

TRIANGULAR RUBBER WHEEL CHOCK

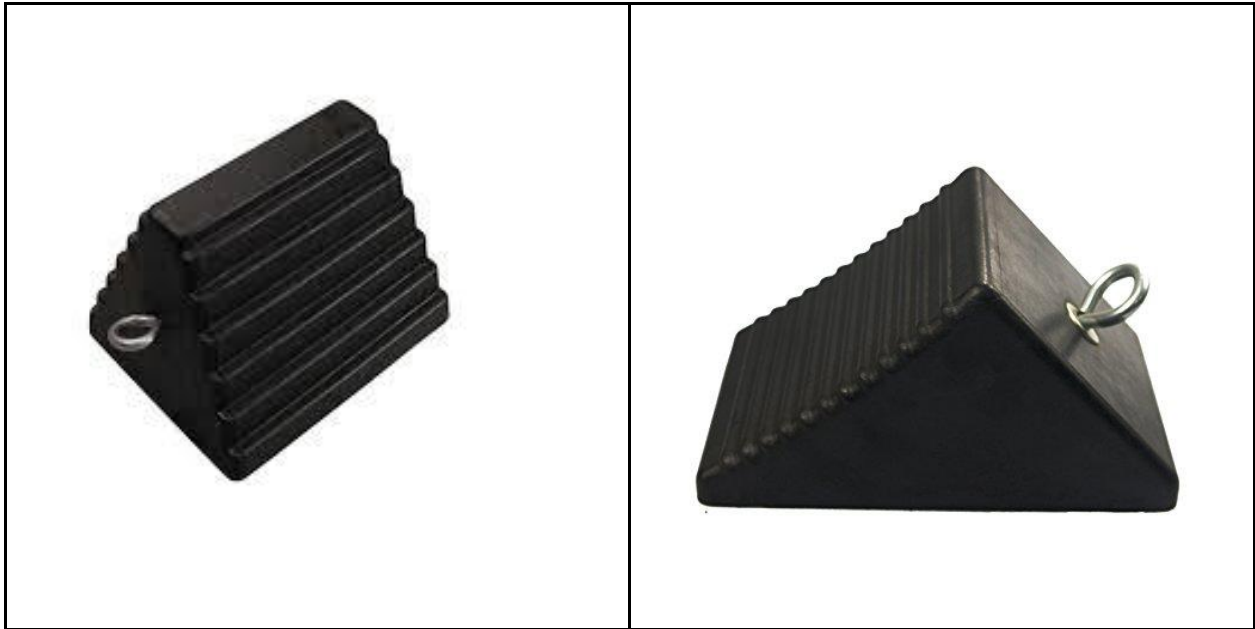

BRAKE CRANK / SPINDELBREMSE

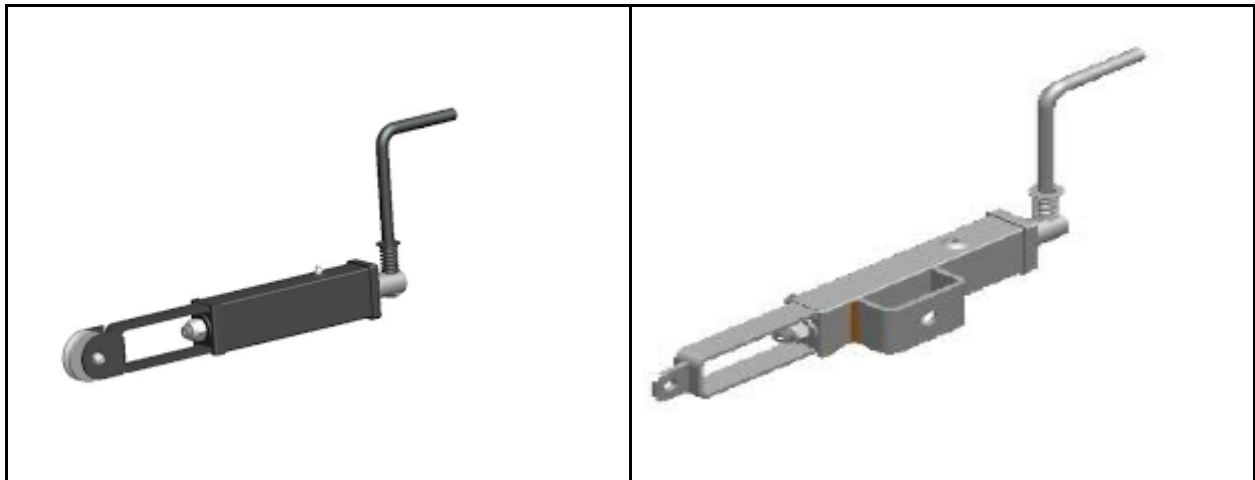

RUBBER SPRING BOLSTER



SPRING SHOE / FEDERSCHUH

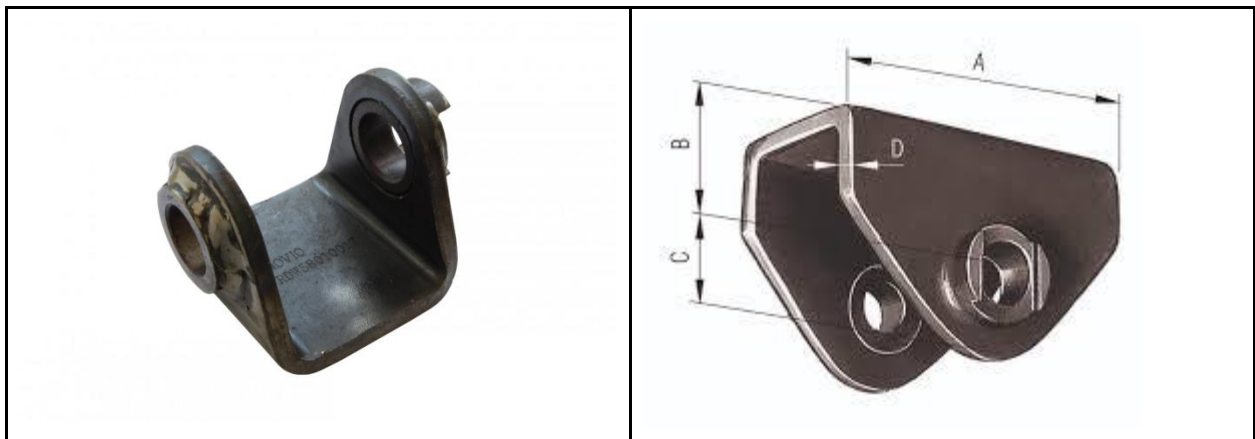

PARKING HOOK FOR WINDING HANDLE



HOOD CATCH / HAUBENHAKEN

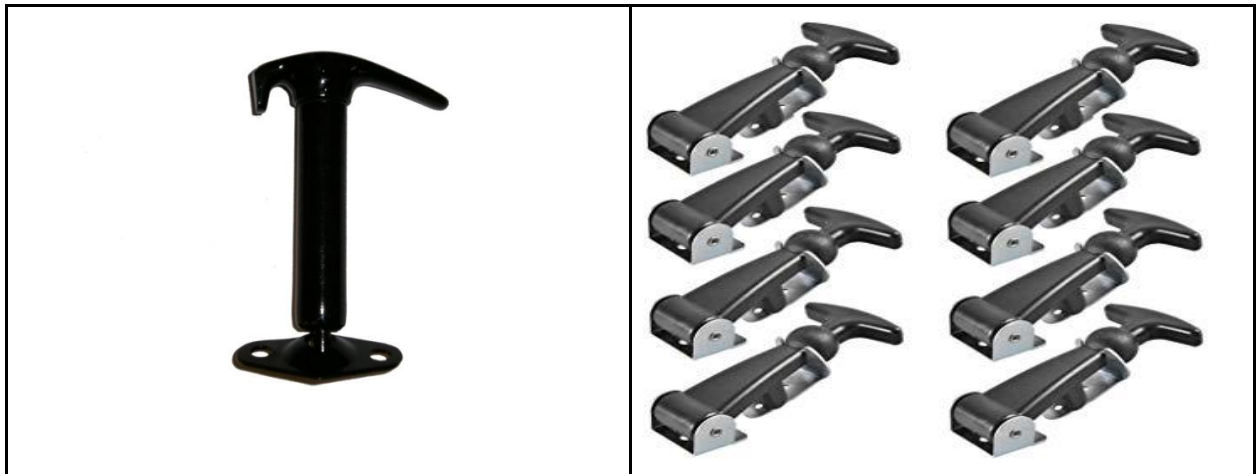

BRASS PLUG CAPS



SILICONE HOSE



PROTECTIVE WIRE CAGE

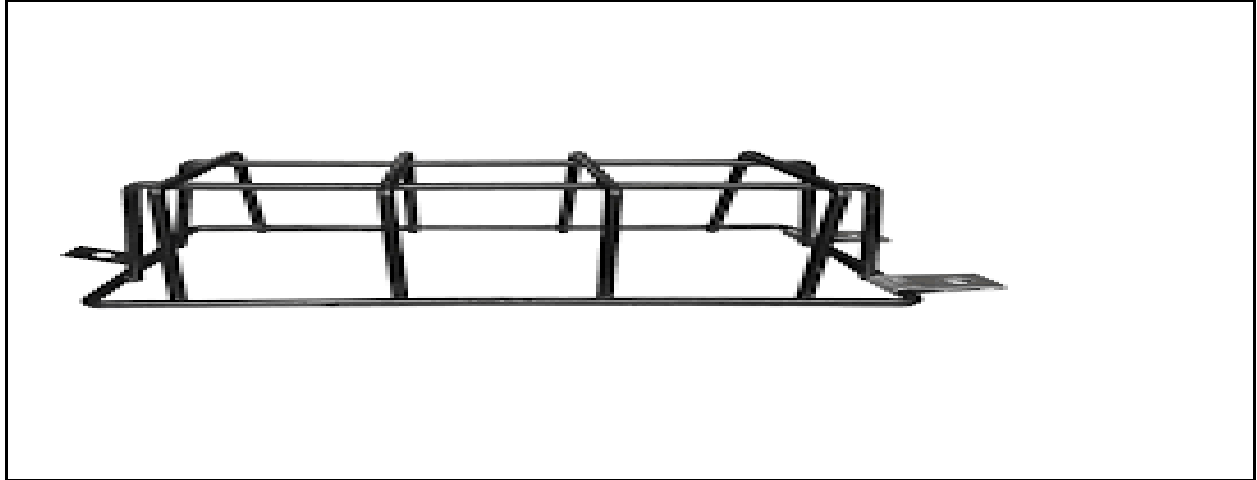

UNIVERSAL FEDERBOLZEN



U-BOLTS FOR SUSPENSION SYSTEMS

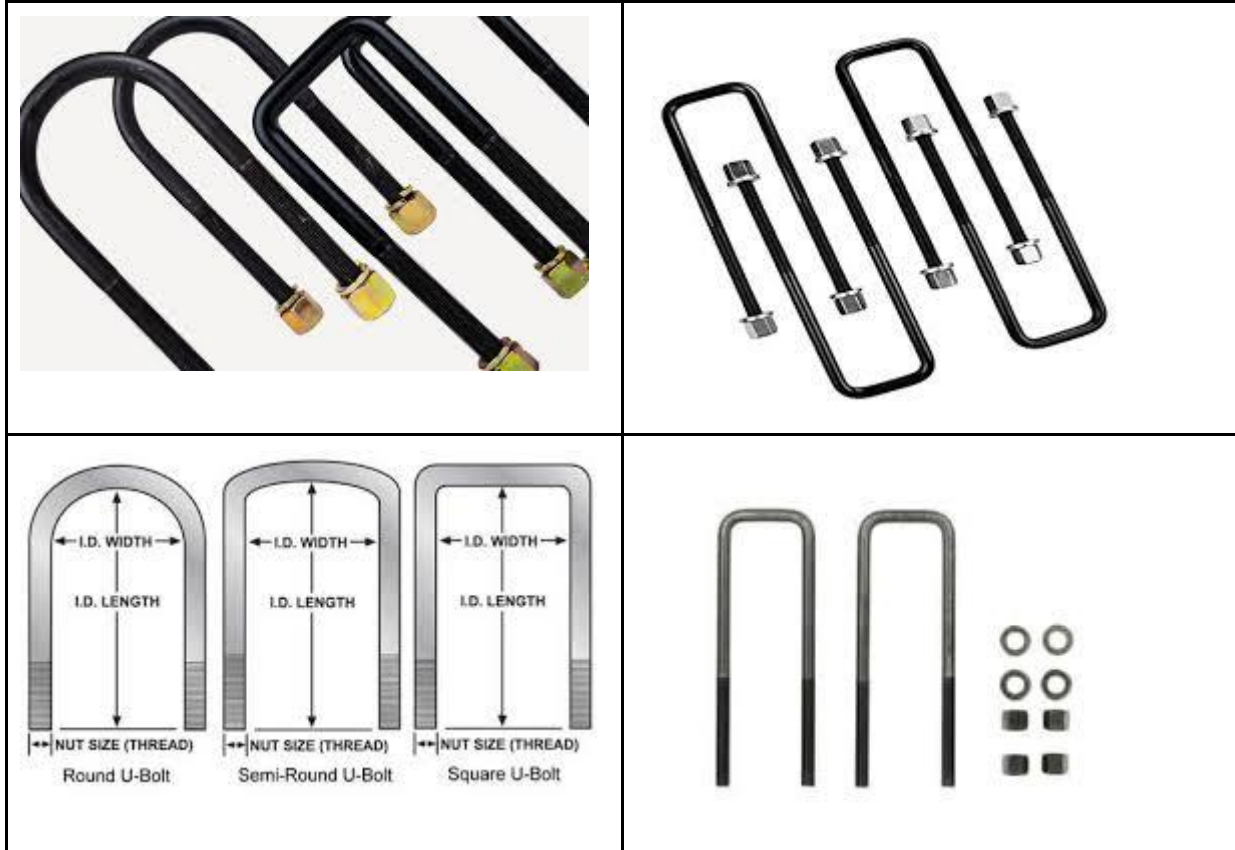

A02985



TRUCK & TRAILER PARTS

 <p>Fifth Wheel Brake Shoe Repair Kit</p>	 <p>Brake Shoe Repair Kit York</p>	 <p>Brake Shoe Repair Kit ROR</p>
 <p>ROR Brake Shoe Repair Kit</p>	 <p>ROR Brake Shoe Repair Kit</p>	 <p>BPW Brake Shoe Repair Kit</p>
 <p>York Brake Shoe Repair Kit</p>	 <p>Mercedes Brake Shoe Repair Kit</p>	 <p>Mercedes Brake Shoe Repair Kit</p>
 <p>BPW Brake Shoe Repair Kit 40 No. KIT</p>	 <p>BPW Brake Shoe Repair Kit</p>	 <p>ROR AXL-132 Brake Shoe Repair Kit</p>
 <p>BPW Cam Shaft Kit</p>	 <p>ROR AXL-122 Brake Shoe Repair Kit</p>	 <p>Mercedes Brake Shoe Repair Kit</p>



Mercedes Marcopol Side Rod End



Rubber Boot 44mm



Rubber Boot 50mm



BPW Washer 5mm



BPW Axle Nut 12,14,16 Ton



BPW Trust Corn 12,14,16 Ton All Type



BPW Jessei Ring 12 & 16 TON



U Clip



Air Cleaner Clip



U Clip



BPW CAM Shaft Bush 36 whole



BPW Brake Shoe Pin



BPW Nylon Ring 10 TON



BPW Nylon Ring 14 TON



BPW Nylon Ring 16 TON



Coil Spring



Valve Spring Set



Valve Spring Kit



Industrial Spring All Type Auto Parts



Industrial Spring All Type Auto Torsion



Flat Wire Spring



Hardware Door Closer Spring All Size



Hardware Door Closer Stopper Spring



Hardware Parts



Hardware Flat Wire Spring Lock



Door Closer Spring 4mm 2.6 Inner



Door Closer Spring 4mm 2.6 Inner



Stopper Spring Hardware



Double Wire Clamp Spring



Double Wire Clamp Spring



BPW Cam Shaft Kit



Mercedes Brake Kaliper Kit



Driver Cabin Suspension Kit



Axle 125/132 ROR Set



Brake Shoe Repair Kit Cabin



Axle Part Repair Kit



Mercedes Spring Pin Kit Rear



Mercedes Spring Pin Kit Front



ROR Roller AI Type Brake



ROR Cam Shaft Kit



ROR Cam Shaft Kit



ROR Kit 117



ROR 126



Washer Kit



Volvo Kit



5mm Combine Finger



3.6 & 5mm Ten Spring



7mm Combine Finger



4.5 Combine Finger



5mm Combine Finger



6m Hanger Set



5mm Hanger



4.5mm & 7mm Combine Finger Set



6mm Ten Spring



All Type Combine Spring



Combine Spring Brake



2.6 & 3.6 Combine Finger



2.6 & 3.6 Combine Finger



Hanger & Finger Set



Agricultural Combine Spring Working



Mercedes Spring Mounting



Centre Bearing 60mm



Driver Cabin



BPW BUSH 36x57x102



Spring Cushion 12 & 16 TON



Axle Part Repair Kit



Bharat Benz Torque Road Bush



Bharat Benz 88mm Bush



Bharat Benz 70mm Bush



Bharat Benz 74mm Bush



Bharat Benz 80mm



Bharat Benz 36mm Bush



Mercedes & BPW Hose Pipe



BPW All Type Suspension Bush



70mm Centre Bearing



Spring Flat Wire



Self Spring Garrai All Type Spring



Tractor Sheet Spring



Tractor Clutch Paddle Spring



Flat Wire 25mm to 55mm Tie Road Lock With Powder Coating



Link Bar 24mm Lock



1.8mm Ring 12mm to 35mm with Powder Coating & Zinc



All Type of Tie Road Spring



Tie Road Spring



Tie Road Taper Spring Suspension



TATA Set of 12, 15, 16, 21, 9 All Type Pressure Plate Spring



Doors Closer Spring



Tractor Combine Finger Spring



BPW 12 & 16 Brass Bushes



All Type Brass Bush BPW & Mercedes



BPW Brass Bush
Part No. 3353240050
Size : 48x40x42



BPW Brass Bush
Part No. 0311233080
Size : 40x36x60



Thrust Washer Differential Kit
Part No.: 3463530582



Part No. : 0311299020
BPW Bush 12 Ton
Size : 130x145x214



Part No. : 0311299040
BPW Bush 16 Ton
Size : 185x200x243



Part No. 3353910050
Mercedes Bush
Size : 40x30x90



Part No. 3703220050
Size : 30x25x61
Mercedes Front Bush



Part No. 3043240060
Size : 30x36x90
Mercedes Rear Bush



Part No. 0310990220
Size : 42x46x72.5
BPW Cam Shaft Bush



Part No. 21204703
Size : 38x47.7x50
Meritor ROR Bush



Part No. 21209990
Size : 43x48x50
Meritor ROR Bush



Part No. CF100117
Size : 32x35x36.5
Anchor Pin Bush



Part No. 21016666
Size : 32x35x36.5
Meritor ROR Bush



Part No. 0311244220
Size : 42x46x77
Cam Shaft Bush BPW



Size : 30x34x42x21
Mercedes Brake Shoe Bush



Part No : ARJA-0199-0703
Fruehauf 420 MM
Brake Shoe Repair Kit



Part No : AEJB0003001
Cam Shaft Kit
Fruehauf



Part No : 0980100431
BPW Cam Shaft Kit
12 pc Kit



Part No : 0980100410
BPW Cam Shaft Kit
8pc Kit



Part No : 3604200441
Mercedes Cam Shaft Kit
24pc Kit



Part No : 0980102010
BPW Brake Shoe Repair Kit



Center Bolt All Size



PART NO. : SK 42158
BPW
FIFTH WHEEL LOCK RING



SK 10515
FIFTH WHEEL LOCK JOST



Part No. 0035000130
Brake S Lock



Part No. 09801020909
Brake Shoe Repair Kit



Stock Plate
Part No. 3464230157
Size Inner Dia 39/42
Outer Dia 60.2
Thickness 3mm

















Stock Plate
Part No. 3464230057
Size Inner Dia 39/42
Outer Dia 76.2
Thickness 3mm



Size 38x48/52x22
CAM Shaft Bearing



Part No. 21204602
Cam Shaft Bearing
Size 38x48/52

 <p>Spring Slack Adjuster 05.397.26.03.0</p>	 <p>SPRING SLACK ADJUSTER 05.397.26.02.0</p>	 <p>BRAKE SHOE SPRING 05.397.34.10.0, 05.397.34.11.0</p>
 <p>BRAKE SHOE SPRING 03.397.44.06.0</p>	 <p>BRAKE SHOE SPRING REAR 346.993.0310</p>	 <p>BRAKE SHOE SPRING FRONT 619.993.0610</p>
 <p>BRAKE SHOE SPRING 05.397.58.03.0</p>	 <p>BRAKE SHOE SPRING 05.397.46.03.0</p>	 <p>05.397.46.03.0 BRAKE SHOE SPRING SCANIA</p>
 <p>BRAKE SHOE SPRING M-002874</p>	 <p>BRAKE SHOE SPRING 03.397.33.06.0</p>	 <p>BRAKE SHOE SPRING 03.397.33.07.0</p>
 <p>SPRING SLACK ADJUSTER 05.397.26.05.0</p>	 <p>SPRING SLACK ADJUSTER 21205194</p>	 <p>BRAKE SHOE SPRING 21221224</p>



3529931910
MERCEDES BENZ
ACLERATOR SPRING



3529931910
MERCEDES BENZ
ACLERATOR SPRING



Part No : 21006612
RETAINING SPRING



Part No : 3039930410
BRAKE SHOE SPRING



Part No : 3359930510
BRAKE SHOE SPRING



Part No : 3469930810
BPW Brake Shoe Repair Kit



120824
Brake Shoe Spring Scania



194592
Brake Shoe Vovio Spring Scania



1309465
Brake Shoe Spring Scania



81976100115
Brake S Lock



0323213020
LOCK PLATE BPW



0318802020
BPW HOOKED SPRING
C CLIP



0262015801
COTTER PIN BPW
SIZE 8X90



0331039020
JESSAR RING BPW 16 TON
SIZE 185X10X220



9 MM CABIN SPRING
BPW

CONTACT INFORMATION

Invicta India Pvt. Ltd.
N-258/B GK-1
New Delhi
India

REX Consolidated
80 DLF Industrial Area Phase I
Faridabad Haryana-121003
India

© Copyright 2020 Invicta India Pvt. Ltd.

All information and data stated in this Product Range document has been compiled with utmost care. Nevertheless, Invicta accepts no liability for any errors, omissions or other inaccuracies contained herein. Subject to change without notice. Reprinting or reproduction, in whole or in part, including of photographs, illustrations or graphics, is not permitted without the prior written consent of Invicta India Pvt. Ltd.. We reserve all rights in connection with this document.

Any similarity or resemblance is unintended and is merely a coincidence.

The vehicle applications cited in this Product Range document may possibly be valid only up to the date printed on the last page of the document. All references made in this Product Range document to the item numbers of vehicle manufacturers and/or competitors are provided for the purpose of comparison only. Such information is not allowed to be used in invoices issued to vehicle owners.

For enquiries, please email us : rahul@invictaindia.com