

INVICTA INDIA AGRICULTURE COMPONENTS CATALOGUE





Colour	Clear Lacquer Coated
Material	EN8D / SAE1045
Heat Treatment	Induction Hard Cutting Edges, Double Hard



Colour	JD Green Coated
Material	EN8D / SAE1045
Heat Treatment	Induction Hard Cutting Edges



Colour	Clear Lacquer Coated
Material	EN8D / SAE1045
Heat Treatment	Induction Hard Cutting Edges



Colour	Yellow Coated
Material	EN8D / SAE1045
Heat Treatment	Induction Hard Cutting Edges, Double Hard



Colour	Black Coated
Material	EN8D / SAE1045
Heat Treatment	Induction Hard Cutting Edges



Colour	Black Coated
Material	EN8D / SAE1045
Heat Treatment	Induction Hard Cutting Edges, Double Hard



Colour	Clear Lacquer Coated
Material	EN8D / SAE1045
Heat Treatment	Induction Hard Cutting Edges, Double Hard



Colour	Clear Lacquer Coated
Material	EN8D / SAE1045
Heat Treatment	Induction Hard Cutting Edges



Colour	Clear Lacquer Coated
Material	EN8D / SAE1045
Heat Treatment	Induction Hard Cutting Edges



Colour	Black Coated
Material	EN8D / SAE1045
Heat Treatment	Induction Hard Cutting Edges



Colour	Clear Lacquer Coated
Material	EN8D / SAE1045
Heat Treatment	Induction Hard Cutting Edges, Double Hard



Colour	Red Coated
Material	EN8D / SAE1045
Heat Treatment	Induction Hard Cutting Edges



Colour	Clear Lacquer Coated
Material	EN8D / SAE1045
Heat Treatment	Induction Hard Cutting Edges



Colour	Clear Lacquer Coated
Material	EN8D / SAE1045
Heat Treatment	Induction Hard Cutting Edges



Colour	Black Coated
Material	EN8D / SAE1045
Heat Treatment	Induction Hard Cutting Edges



Colour	Clear Lacquer Coated
Material	EN8D / SAE1045
Heat Treatment	Induction Hard Cutting Edges, Double Hard



Colour	Clear Lacquer Coated
Material	EN8D / SAE1045
Heat Treatment	Induction Hard Cutting Edges, Double Hard



Colour	Clear Lacquer Coated
Material	EN8D / SAE1045
Heat Treatment	Induction Hard Cutting Edges, Double Hard



Colour	Clear Lacquer Coated
Material	EN8D / SAE1045
Heat Treatment	Induction Hard Cutting Edges, Double Hard



Colour	JD Green Coated
Material	EN8D / SAE1045
Heat Treatment	Double Hard
Bolt	Grade 10.9



Colour	JD Green Coated
Material	EN8D / SAE1045
Heat Treatment	Double Hard
Bolt	Grade 10.9



Colour	Golden Plating
Material	EN8D
Heat Treatment	Induction Hard



Colour	Self
Material	EN8D
Heat Treatment	Induction Hard



Colour	Yellow
Material	EN8D
Heat Treatment	Induction Hard



Blade Class

Width	76mm
Length	83mm
Thickness	2mm
Hole Dia	6.5mm

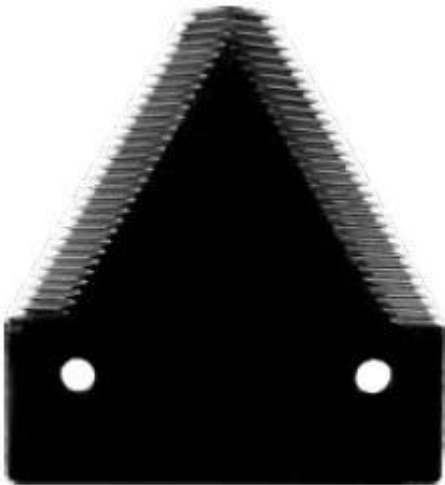

Blade Class (Heavy Duty)

Width	76mm
Length	83mm
Thickness	3mm
Hole Dia	6.5mm



Blade GDR (5.5)

Width	76mm
Length	75mm
Thickness	2mm
Hole Dia	5.5mm



Blade GDR (6.5)

Width	76mm
Length	75mm
Thickness	2mm
Hole Dia	6.5mm

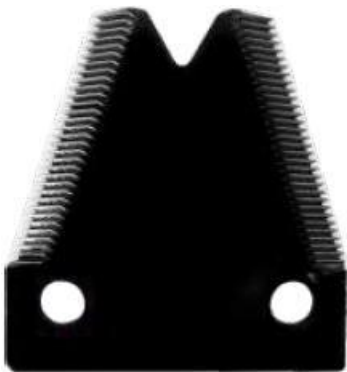

Blade Reaper (Heavy Duty)

Width	76mm
Length	80mm
Thickness	2mm
Hole Dia	10.5mm

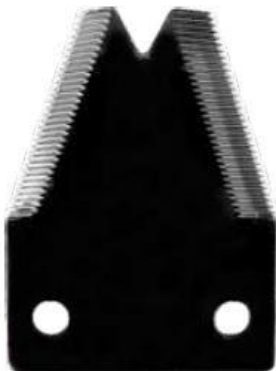

Blade Thresher

Width	76mm
Length	102mm, 125mm
Thickness	3mm, 4mm
Hole Dia	10.5mm



Blade Thresher (Knife Type)

Width	36mm
Length	120mm
Thickness	4mm
Hole Dia	13mm

Blade Thresher KT-1

Width	30mm
Length	144mm
Thickness	4mm
Hole Dia	10.5mm

Tailor Frame



Counter Frame



A Frame CAT - 2



Loader Bracket



Hook Kit



Hook



Euro Bracket



Euro Bracket Hooks



Euro Bracket Hooks



Euro Bracket Arm



Item Code





COUNTER FRAME



A-FRAME CAT - 2 LIGHT DUTY



A-FRAME CAT - 1
A-FRAME CAT - 2



BALE FORK



CONVERSION KIT (Pair)



BALE FORK

Conversion Bushing

Outer Dia. ØA (mm, inches)	Inner Dia. ØB (mm, inches)	Length C (mm, inches)	Weight (kg.)
25.40 1"	19.50 0.75"	50.80 2"	0.18
25.40 1"	19.05 0.75"	41.20 1.62"	0.14
31.75 1.25"	25.40 1"	50.80 2"	0.24
27.57 1.12"	22.22 0.87"	35.00 1.38"	0.18
28.57 1.12"	22.22 0.87"	35.00 1.38"	0.18
36.50 1.44"	28.57 1.12"	44.45 1.75"	0.29
36.50 1.44"	28.57 1.12"	69.80 2.75"	0.50
36.50 1.44"	28.57 1.12"	82.50 3.25"	0.52
19.05 0.75"	15.87 0.62"	41.27 1.62"	0.10
25.40 1"	19.05 0.75"	49.21 1.94"	0.20
31.75 1.25"	25.40 1"	49.21 1.94"	0.20
22.22 0.87"	15.87 0.62"	34.92 1.37"	0.10

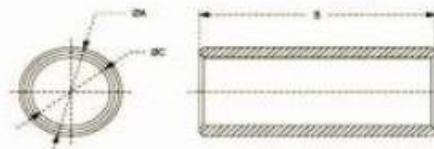

Dia. ØA (mm)	Dim. B (mm)	Dim. ØC (mm)
19	41	16
22	35	16
25.4	41	19
25.4	50.8	19
28.4	44	22.4
28.4	63	22.2
28.6	35	22.2
28.6	44	22.2
28.6	50.8	22.2
32	50.8	25.4
36.5	44.5	28.6
36.5	51	28.6
36.5	64	28.6
37.8	44	28.4

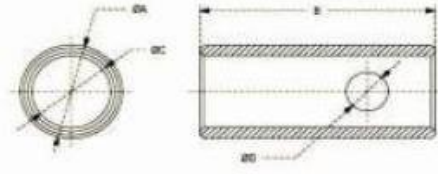

Conversion Bushing

Dim. ØA (mm)	Dim. B (mm)	Dim. ØC (mm)	Dim. ØD (mm)
28	64	22	12
36.5	63.5	28.6	17

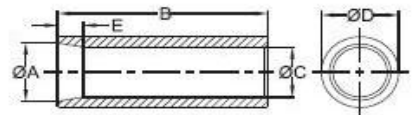
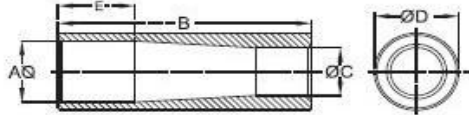
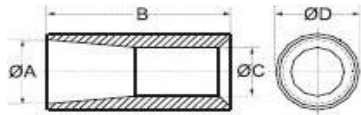

Type - A

Type - B

Type - c

Tines Bushing

Dim. ØA (mm)	Dim. B (mm)	Dim. ØC (mm)	Dim. ØD (mm)	Dim. E (mm)	Type
34.50	110	24.50	50	-	A
42.00	110	32.00	50	-	A
44.00	120	32.00	57	-	A
43.5	165	34	55	50	B
35	115	27	42.4	20	C

Quick Hitch Adaptor Bushing

Cat.	Inside Dia (mm)	Dim. ØC (mm)
1	22.22	102
2	28.54	102



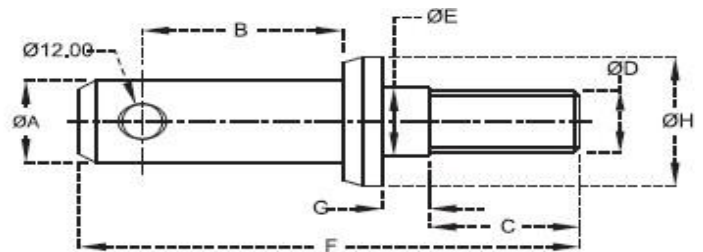

Lift Arm Pins

Dia. ØA (mm)	Dim. B (mm)	Dim. C (mm)	Thread ØD (mm)	Dia. ØE (mm)	Dim. F (mm)	Dim. G (mm)	Dia. ØH (mm)
22	46	45	18 X 1.5	18	130	5	37
22	50	40	20 X 1.5	20	130	5	38
22	50	40	22 X 1.5	22	140	14	38
22	50	40	22 X 1.5	28	140	14	38
22	60	40	22 X 1.5	25	150	20	32
25	60	40	22 X 1.5	25	150	20	40
25	60	40	22 X 1.5	28	150	20	38
28	50	30	30 X 2	30	155	50	50
28	60	45	22 X 1.5	22	150	14	44
28	55	45	22 X 1.5	24	150	14	42
28	55	45	24 X 1.5	24	150	15	43
28	60	40	22 X 1.5	28	150	20	43
28	55	45	27 X 1.5	28	150	14	42
28	58	48	27 X 1.5	27	147	10	43
36.5	61	60	27 X 1.5	27	165	11	50

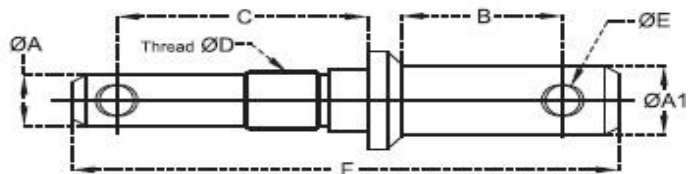

Lift Arm Pins - Dual Mounting

Dia. ØA (mm)	Dia. ØA1 (mm)	Dim. B (mm)	Dim. C (mm)	Thread ØD (mm)	Dia. ØE (mm)	Dim. F (mm)
22.00	28	58	90	24 X 2	12	195
22.00	28	58	90	27 X 3	12	195

Top Link Pins (With Linch Pin)

Dim. ØA (mm)	Dim. ØB (mm)	Dim. ØC (mm)	Dim. ØD (mm)
14.3	84	73	6
19	92	77	6
19	120	100	8
19	120	108	8
25	120	98	8
25	120	100	11

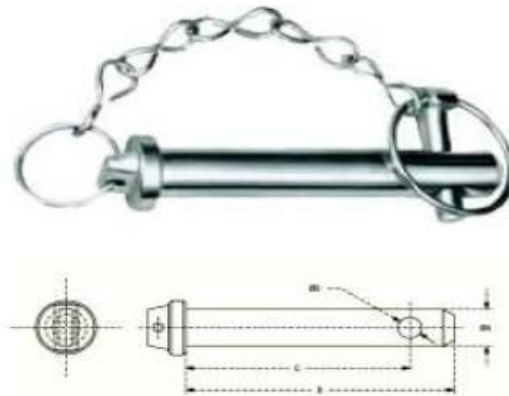

Top Link Pins (Headless)

Cat.	Dim. ØA (mm)	Dim. B (mm)	Dim. C (mm)	Dim. ØD (mm)	Dim. E (mm)
1	19	140	96	12	22
1	19	170	126	12	22
1	19	207	163	12	22
1	19	254	210	12	22
-	22	140	96	12	22
-	22	170	126	12	22
2	25	147	100	12	22
2	25	164	120	12	22
2	25	210	166	12	22
2	25	254	210	12	22
2	25	294	250	12	22

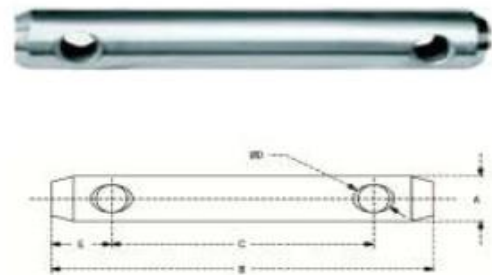

Knotching Pins

Dim. ØA (mm)	Dim. B (mm)	Dim. C (mm)	Dim. ØD (mm)
22	130	93	12
28	143	100	12

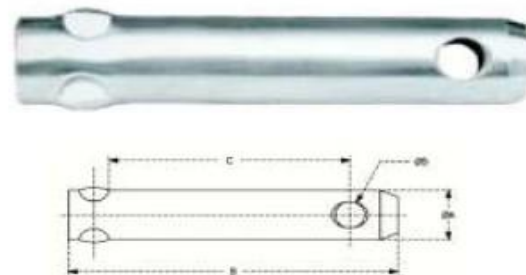

Hitch Pin With Red Handle (Vinyl Coating)

Dia. ØA (mm)	Dia. ØB (mm)	Dia. C (mm)	Weight (kg.)
12.70	5.0	92.07	0.23
15.87	6.7	101.60	0.35
15.87	6.7	139.70	0.45
19.05	6.7	101.60	0.47
19.05	6.7	165.10	0.63
22.22	6.7	165.10	0.80
25.40	6.7	190.50	1.08
28.57	6.7	215.90	1.55
31.75	6.7	215.90	0.35
38.10	6.7	215.90	1.85
15.87	6.7	146.05	0.50

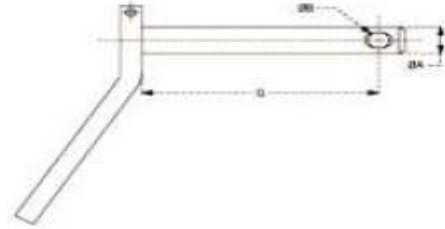

Hitch Pin With & Without Linch Pin & Chain

Pin Dia. ØA (mm, inches)	Drill Dia. ØB (mm, inches)	Collar Dia. ØC (mm, inches)	Usable length D (mm, inches)	Weight lbs.
12.70 0.50"	5.0 0.20"	25.40 1"	88.90 3.50"	0.48
15.87 0.62"	6.7 0.26"	32.00 1.26"	107.95 4.25"	0.66
15.87 0.62"	6.7 0.26"	32.00 1.26"	158.75 6.25"	0.88
19.05 0.75"	6.7 0.26"	38.00 1.50"	107.95 4.25"	0.97
19.05 0.75"	6.7 0.26"	38.00 1.50"	158.75 6.25"	1.21
22.22 0.87"	6.7 0.26"	44.50 1.75"	107.95 4.25"	1.32
22.22 0.87"	6.7 0.26"	44.50 1.75"	158.75 6.25"	1.54
25.40 1"	6.7 0.26"	51.00 2.01"	107.95 4.25"	1.76
25.40 1"	6.7 0.26"	51.00 2.01"	158.75 6.25"	1.97
28.57 1.12"	6.7 0.26"	57.00 2.24"	158.75 6.25"	2.53
31.75 1.25"	6.7 0.26"	63.00 2.48"	190.50 7.50"	3.20

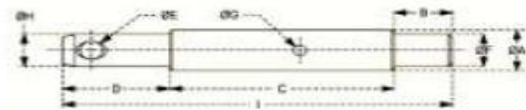

Bent Handle Hitch Pins (With & Without Linch Pin, Chain)

Dim. ØA (mm)	Dim. ØB (mm)	Dim. ØC (mm)
19	12	123
19	12	130
19	12	135
19	12	175
22	12	123
22	12	130
22	12	135
22	12	175
15	12	123
15	12	130
15	12	135
15	12	175
28	12	123
28	12	130
28	12	135
28	12	175
32	12	175



Implement Mounting Pins (Double)

Dim. ØA (mm)	Dim. B (mm)	Dim. C (mm)	Dim. D (mm)	Dim. ØE (mm)	Dim. ØF (mm)	Dim. G (mm)	Dim. H (mm)	Dim. I (mm)
28	30	115	55	12	22	6.5	22	200
28	30	115	55	12	22	6.5	25	200



Implement Mounting Pins (Double)

Dim. ØA (mm)	Dim. B (mm)	Dim. C (mm)	Dim. D (mm)	Dim. ØE (mm)	Dim. ØF (mm)	Dim. G (mm)	Dim. H (mm)	Dim. I (mm)
25	40	70	100	12	19	80	20	210
25	38	96	78	12	19	62	22	212
25	26	66	78	6.5	19	70	18	170
28	35	75	90	12	22	75	20	200
28	40	70	100	12	22	80	20	210
28	40	90	10	12	22	80	20	230
28.6	40	89	100	12	22.2	80	20	220
32	40	115	95	12	25	81	26	250
36.5	36	150	91	12	28	81	26	277
36.5	45	150	95	12	28	80	28	290

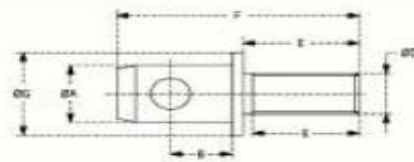

Stabilizer Pins

Dim. ØA (mm)	Dim. B (mm)	Dim. C (mm)	Thread ØD (inches)	Dim. ØE (mm)	Dim. ØF (mm)	Dim. G (mm)	Dim. H (mm)	Dim. I (mm)
19	19	28.6	3/4"UNF	35	73	27	27	38
22	17	28.6	5/8"UNF	32	67	29	15.9	35
22	18.7	28.6	5/8"UNF	32	73	29.50	15.9	41
22.2	32	28.6	5/8"UNF	32	79	29	15.9	47

CHAINS

Suitable for FIAT



Suitable for FORD
Suitable for FORD



Suitable for Massey Ferguson



Suitable for Massey Ferguson



Universal Stabilizer Chain
Universal Stabilizer Chain



Suitable for FORD
Suitable for FORD



Suitable for URSUS



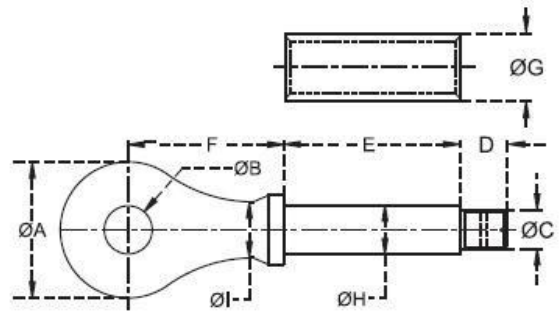

Hitch Eye

Dia. ØA (mm)	Dia. ØB (mm)	Thread ØC (mm)	Dim. D (mm)	Dim. E (mm)	Dim. F (mm)	Dia. ØG (mm)	Dia. ØH (mm)	Dia. ØI (mm)	Towing Load Limit (Kg.)	Vertical Load Limit (Kg.)
84	29	M24	30	109	100	42	30	35	1500	300

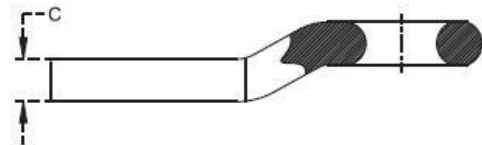
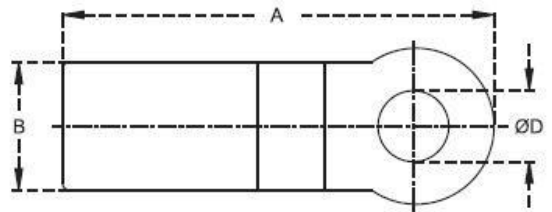

Towing Eye (Weld - on Type)

Dim. A (mm)	Dim. B (mm)	Dim. C (mm)	Dia. ØD (mm)	Type
305	90	29	50	Cranked
305	90	29	50	Straight
305	90	38	50	Straight



P.T.O. Adaptors With Bolts

Spline Size (Male)	Spline Size (Female)	Total Length (mm)
1-3/8"x 6	1-3/8"x 6	150
1-3/8"x 6	1-3/8"x 6	165
1-3/8"x 6	1-3/8"x 21	150
1-3/8"x 6	1-3/4"x 20	150
1-3/4"x 6	1-3/8"x 6	160

P.T.O. Adaptors With Button

Spline Size (Male)	Spline Size (Female)	Total Length (mm)
1-3/8"x 6	1-3/8"x 6	150
1-3/8"x 6	1-3/4"x 20	165
1-3/8"x 6	1-3/8"x 21	150
1-3/8"x 21	1-3/8"x 6	150
1-3/4"x 6	1-3/8"x 6	160
1-3/4"x 6	1-3/4"x 20	165
1-3/4"x 6	1-3/8"x 21	160



P.T.O. Adaptors

Spline Size (Male)	Spline Size (Female)	Total Length (mm)
1-3/8"x 6	1-3/8"x 6	150
1-3/8"x 6	16 UNI 221 16x20x4 mm x 6	120
1-3/8"x 6	21 UNI 221 21x25x5 mm x 6	140
1-3/8"x 6	26 UNI 220 26x30x6 mm x 6	140

PT.O. Adaptors With Hole

Spline Size (Male)	Spline Size (Female)	Total Length (mm)
1-3/8"x 6	20 without Slot	120
1-3/8"x 6	25 without Slot	120
1-3/8"x 6	30 without Slot	120
1-3/8"x 6	20 with Slot 6x2.8	145
1-3/8"x 6	25 with Slot 8x3.3	145
1-3/8"x 6	30 with Slot 8x3.3	145



P.T.O. Bushing

Spline Size (Male)	Spline Size (Female)	Total Length (mm)
1-3/8"x 6	1-1/8"x 6	76
1-3/8"x 6	1-1/8"x 6	47.5

Splined Couplings

Spline Size (Female)	Dia. Ø (mm)	Total Length (mm)
1-3/8"x 6	48	80
1-3/8"x 6	48	100
1-3/8"x 6	48	130
1-3/8"x 6	48	150
1-3/4"x 6	60	70
1-3/4"x 6	60	100
1-3/4"x 6	60	130





Stabiliser

Description	Weight lbs.
Minimum / Maximum Length: 394mm / 450mm	11.464
Min 16" - Max 21"	



Stabiliser

Description	Weight lbs.
Length: 450mm	4.62



Pick Up Hitch Lift Rod

Description	Weight lbs.
Suitable for 11" x 32" Wheels Only	7.40
Adj Min 460mm Max 830mm	6.83



Stabiliser

Description	Info	Weight lbs.
Minimum / Maximum Length: 450mm / 640mm (Heavy Duty)	Eye 25mm Bolt 25mm	16.31
Minimum / Maximum Length: 430mm / 490mm (Heavy Duty)	Eye 20mm Bolt 20mm	16.00
Minimum / Maximum Length: 440mm / 600mm (Heavy Duty)	Eye 20mm Bolt 25mm	15.00



Stabiliser

Description	Info	Weight lbs.
Minimum / Maximum Length: 470mm / 620mm	Eye 20mm Bolt 20mm	12.56
Minimum / Maximum Length: 440mm / 660mm	Eye 25mm - Bolt 25mm	12.70
Minimum / Maximum Length: 440mm / 600mm	Eye 20mm - Bolt 25mm	13.22



Draw Bar Stay Arm

Description	Weight lbs.
Suitable for 11" x 32" Wheels Only	6.75

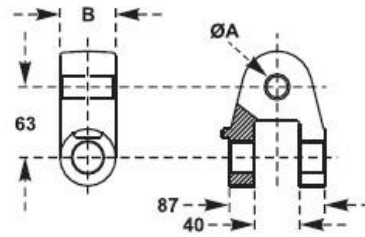

End For Articulated Yoke

Dia. ØA (mm)	Dim. B (mm)
19.2	51
20.2	51
22.1	51
25.4	51
28.2	51
30.2	51
32	51

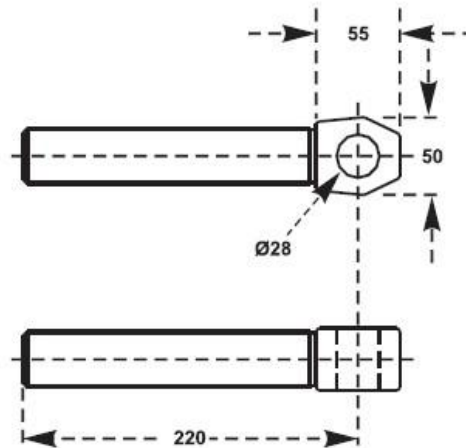

Tie Rod For Articulated Yoke

Thread (mm)
M 30X3 R
M 30X3 L
M 30X3.5 R
M 30X3.5 L
M 36X3 R
M 36X3 L
M 40X3 R
M 40X3 L

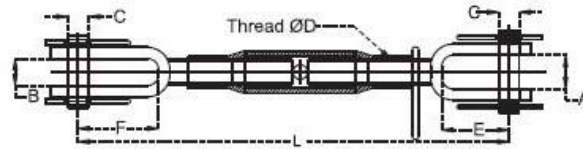

Adjustable Leveling Arm

Dim. A (mm)	Dim. B (mm)	Dia. ØC (mm)	Thread ØD (mm)	Dim. E (mm)	Dim. F (mm)	Dim. L Min. (mm)	Dim. L Max. (mm)
30	24	18	22 X 2.5	60	72	380	530
40	24	18	24 X 3	70	72	450	600
40	24	18	27 X 3	70	72	500	650

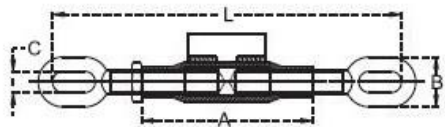

TYPE - A

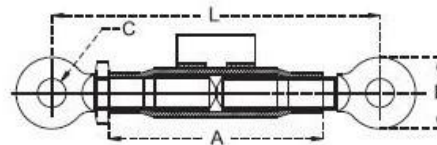

TYPE - B

Stabilisers Adjusters

Dim. L Min. (mm)	Dim. L Max. (mm)	Dim. A (mm)	Dim. B (mm)	Dim. C (mm)	Thread ØD (mm)	Type
245	335	120	35	14	16X2	A
250	350	135	38	14	18X2.5	A
275	370	130	38	14	20X2.5	A
280	390	150	38	14	22X2.5	A
210	300	120	46	18	16X2	B
230	330	130	46	18	20X2.5	B
250	360	150	50	20	22X2.5	B

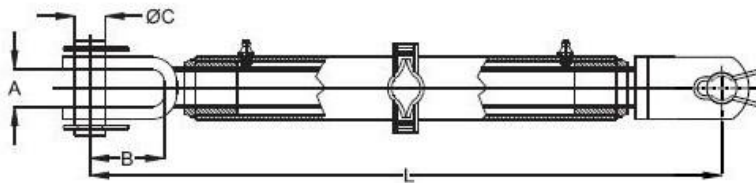

Ratchet Jack

Dim. A (mm)	Dim. B (mm)	Dia. ØC (mm)	Dim. L Min. (mm)	Dim. L Max. (mm)
30	60	24	510	700



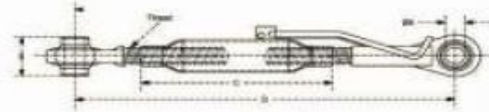

Top Link Assembly suitable for JD

Ball ID ØA (mm)	Ball Length B (mm)	Thread (inches)	Pipe Length C (mm)	Dim. D Man. (mm)	Dim. D Max. (mm)	Weight (kg.)
20, 25.40	44, 51	1-1/8"UNC	320	550	760	5.45
20, 25.40	44, 51	M27x3	320	550	760	
25.40	51	1-1/8" UNC	320	550	760	

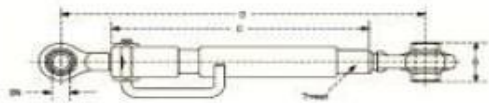

Top Link Assembly suitable for Ford

Cat.	Ball ID ØA (mm)	Ball Length B (mm)	Thread (inches)	Pipe Length C (mm)	Dim. D Man. (mm)	Dim. D Max. (mm)	Weight (kg.)
1	19.05	44	1-1/4"UNC	425	622	794	6.63
1,2	19.05,25.40	44,51	1-1/4"UNC	425	622	794	6.56
2	25.4	51	1-1/4"UNC	425	622	796	6.49
2	25.4	51	1-1/4"UNC	485	685	857	

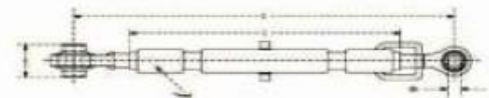

Top Link Assembly suitable for MF

Cat.	Ball ID ØA (mm)	Ball Length B (mm)	Thread (inches)	Pipe Length C (mm)	Dim. D Man. (mm)	Dim. D Max. (mm)	Weight (kg.)
1	19.05	44	1-1/16"UNF	438	590	750	4.59
1	19.05	44	1-1/16"UNF	476	610	770	5.31
1	19.05	44	1-1/16"UNF	546	670	830	5.22
2	25.4	51	1-1/16"UNF	546	670	830	5.40
1,2	19.05,25.40	44,51	1-1/16"UNF	546	670	830	5.45
1,2	19.05,25.40	44,51	1-1/16"UNF	476	610	770	5.52
2	25.4	51	1-1/16"UNF	476	610	770	5.77
1,2	19.05,25.40	44,51	1-1/16"UNF	438	590	750	5.31
2	25.4	51	1-1/16"UNF	438	590	750	4.10

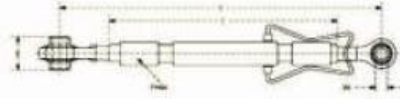

Top Link Assembly suitable for MF

Cat.	Ball ID ØA (mm)	Ball Length B (mm)	Thread (inches)	Pipe Length C (mm)	Dim. D Man. (mm)	Dim. D Max. (mm)	Weight (kg.)
2	25.4	51	1-1/4"UNC	527	680	870	7.99
2	25.4	51	1-1/4"UNC	485	685	860	
2	25.4	51	1-1/4"UNC	425	625	800	
1-2	20,20,25.4	44,51	1-1/4"UNC	425	625	800	

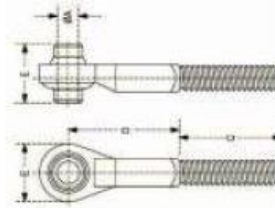

Top Link end suitable for JD

Cat.	Ball ID ØA (mm)	Ball Length B (mm)	Thread (inches)	Dim. C (mm)	Dim. D (mm)	Dim. E (mm)
2	25.4	51	1-1/8"UNC-R	175	162	70
1	20	44	1-1/8"UNC-L	190	56	66
2	25.4	51	M 27 x 3 R	175	162	70
2	20	44	M 27 x 3 L	190	56	66

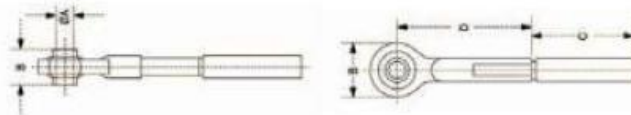

Top Link end suitable for Ford

Cat.	Ball ID ØA (mm)	Ball Length B (mm)	Thread (inches)	Dim. C (mm)	Dim. D (mm)	Dim. E (mm)
1	19	44	1-1/4"UNF-L	128	208	58
2	25.4	51	1-1/4"UNF-L	128	208	76
2	25.4	51	1-1/4"UNF-R	168	86	76

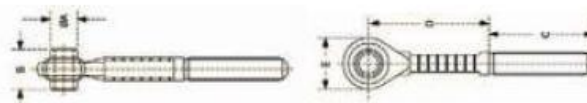

Top Link end suitable for MF

Cat.	Ball ID ØA (mm)	Ball Length B (mm)	Thread (inches)	Dim. C (mm)	Dim. D (mm)	Dim. E (mm)
1	19	44	1-1/16"-R	128	167	58
1	19	44	1-1/16"-L	128	167	58
2	25.4	51	1-1/16"-R	128	167	66
2	25.4	51	1-1/16"-L	128	167	66

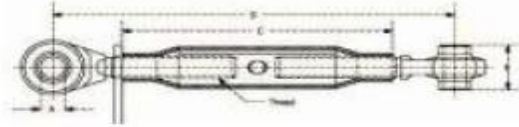

Top Link Assembly (Metric Light Duty)

Ball ID ØA (mm)	Ball Length B (mm)	Thread (inches)	Pipe Length C (mm)	Dim. D Man. (mm)	Dim. D Max. (mm)
16	25.4	20x25	190	265	385
16	25.4	20x25	250	325	470
16	25.4	20x2.5	400	475	695
19	44	22x2.5	160	265	350
19	44	22x2.5	180	290	390
19	44	22x2.5	220	330	470
19	44	22x2.5	230	330	490
19	44	22x2.5	280	380	540
19	44	22x2.5	300	400	560
19	44	24x2.5	245	355	515
19	44	24x2.5	280	390	570
19	44	24x2.5	300	410	590
19	44	24x2.5	320	430	610
19	44	24x2.5	370	480	660
19	44	24x2.5	400	510	690
19	44	27x3	220	330	450
19	44	27x3	275	385	565
19	44	27x3	320	430	640
19	44	27x3	350	460	680
19	44	27x3	370	480	690
19	44	27x3	380	490	710
19	44	27x3	400	510	720
19	44	27x3	430	540	750
19	44	27x3	450	560	780
19	44	27x3	470	580	790
19	44	27x3	500	610	830
19	44	27x3	550	660	880
19	44	27x3	570	680	890
19,25.4	44,51	27x3	320	430	640
19,25.4	44,51	27x3	350	465	700
19,25.4	44,51	27x3	360	480	680
19,25.4	44,51	27x3	370	485	730
19,25.4	44,51	27x3	380	495	745
19,25.4	44,51	27x3	400	515	765
19,25.4	44,51	27x3	430	454	795
19,25.4	44,51	27x3	450	565	815
19,25.4	44,51	27x3	470	585	810
19,25.4	44,51	27x3	500	615	865
19,25.4	44,51	27x3	550	665	915

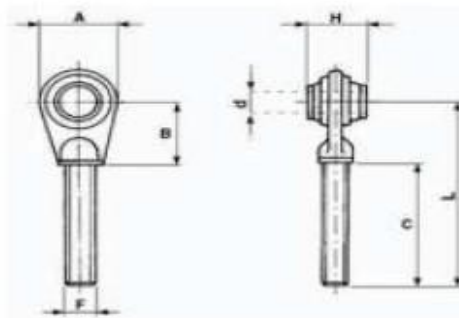

op Link Ends

Pin Hole Dia. ØA (mm, inches)	Hread ØB (inches)	Dim. C (mm, inches)	Dim. D (mm, inches)	Weight lbs.
19.05 0.75"	1-1/8"UNC-LH	143 5.63	197 7.76"	2.30
19.05 0.75"	1-1/8"UNC-RH	143 5.63	197 7.76"	2.30
25.40 1"	1-1/8"UNC-LH	187 7.36"	247 9.72"	3.10
25.40 1"	1-1/8"UNC-RH	187 7.36"	247 9.72"	3.10
25.40 1"	1-1/4"UNC-LH	185 7.28"	270 10.63"	3.90
25.40 1"	1-1/4"UNC-RH	185 7.28"	270 10.63"	3.90
31.75 1.25"	1-3/8"UNC-LH	185 7.28"	260 10.24"	6.10
31.75 1.25"	1-3/8"UNC-RH	185 7.28"	260 10.24"	6.10



Top Link Ends

A mm	B mm	C mm	d mm	F mm	H mm	L mm
52	45	125	19	22 X 2.5	44	170
62	50	115	19	24 X 2.5	44	165
75	55	170	25.4	27 X 3	51	225
75	55	165	25.4	30 X 3	51	220
80	55	165	25.4	36 X 3	51	220
96	70	200	32	36 X 3	51	270

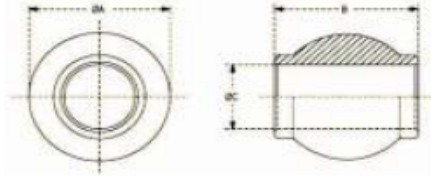

Ball (Top Link)

Dim. ØA (mm)	Dim. ØB (mm)	Dim. ØC (mm)
32	25.4	16
38	25.4	15.9
38	41	19
38	44	19
38	44	20
50	44	19
46	44	20
46	42	25.4
46	44	25.4
46	51	25.4
50	51	22.1
50	44	25.4
50	51	25.4
50.8	44.5	25.4
50.8	44.5	28.4
54	51	25.4
54	55	30
54	51	32
54	55	35
60	51	25.4
60	51	32
38	35	22.1
44	51	20
42	44	19
46	51	22.1
46	45	28.4
46	35	22.1
46	44.5	22.1
46	50	26
46	51	25.4

Dim. ØA (mm)	Dim. ØB (mm)	Dim. ØC (mm)
46	51	20
48	50	25.4
50	44.5	22.1
50	51	19
50	45	28.6
50	49	25.4
50	51	30
50	51	22.1
50	51	25.2
52	45	28.6
54	44	32
54	44	20
54	44	22.1
54	45	28.4
54	51	34
54	55	32
54	60	19
54	50	30
54	50	35
54	51	23
56	51	25.4
60	51	28.4
60	51	37
62	51	25.4
62	51	32
64	55	28.6
78	75	50
78	75	45
78	75	40
78	65	40

Lower Link Ball

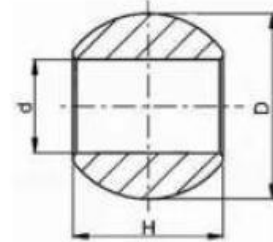
D mm	d mm	H mm
44	22.1	35
56	22	45
56	28	45
64	28.4	45
64	38.2	45
64	37	45



Top Link Locking Collars (Forged)

Dim. A (mm)	Dim. ØB (mm)	Dim. C (mm)	Thread D (mm)
25	34	12	22x2.5
25	34	12	24x25
25	34	12	24x3
40	40	18	27x3
40	40	18	30x3
40	40	18	30x3.5
48	48	23	36x3
50	54	28	40x3

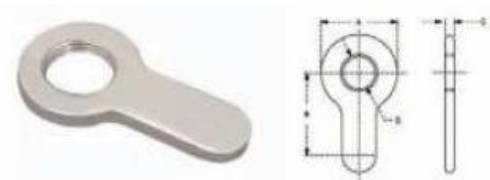
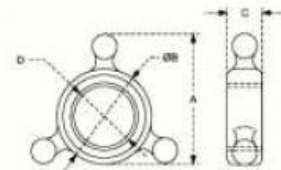

Top Link Locking Collars (Plate)

Dim. A (mm)	Dim. ØB (mm)	Dim. C (mm)	Thread D (mm)
45	60	6	22x2.5
45	60	6	24x25
45	60	6	24x3
45	60	6	27x3
45	60	6	30x3
45	60	6	30x3.5
60	88	10	36x3
60	88	10	40x3



Dim. A (mm)	Dim. ØB (mm)	Dim. C (mm)	Thread D (mm)
45	60	6	22x2.5
45	60	6	24x25
45	60	6	24x3
45	60	6	27x3
45	60	6	30x3
45	60	6	30x3.5
60	88	10	36x3
60	88	10	40x3



Hitch - Pin Balls

Dia. ØA (mm)	Thread Dia. ØB (inches)	Dim. C (mm)	Dim. D (mm)	Dim. E (mm)
50	7/8"	100	162	190
50	1"	100	162	190

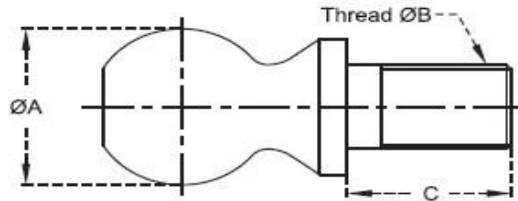

Hitch Balls / Tow Balls

Dia. ØA (mm)	Thread Dia. ØB (inches)	Dim. C (mm)	Max. Load (Kg.)
47.8	3/4" 16UNF	54	900
50.8	3/4" 16UNF	54	1600
50.8	1" 12UNF	54	2300
58.68	1-1/4" 12UNF	54	3400

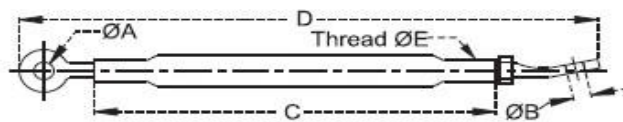

Stabilizer Arm - Adjustable

Dia. ØA (mm)	Dia. ØB (mm)	Dim. C (mm)	Dim. D Min. (mm)	Dim. D Max. (mm)	Thread ØE (mm)
20	23	584	724	889	3/4" UNF
23	23	584	724	889	3/4" UNC
23	23	584	723	914	7/8" UNF



Lower Links

Dia. ØA (mm)	Dim. B (mm)	Dim. ØC (mm)	Dim. ØD (mm)	Usable E (mm)	Weight (kg.)	Material
22.22	806.45	19.05	16.05	60.32	520	Mild Steel
22.22	806.45	19.05	16.05	60.32	5.20	Spring Steel

Weld On Ball Ends

A mm	B mm	C mm	D mm	E mm	F mm	G mm
35	19.30	14	65	40	73	50
35	22.10	14	65	45	73	50
35	25.40	18	83	55	97	70
45	28.40	22	96	65	113	70
45	34.20	24	96	65	113	70
45	38.40	24	108	65	119	80

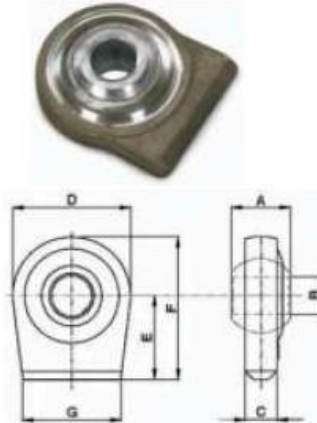

Weld On Ball Ends

A mm	B mm	C mm	D mm	E mm	F mm	G mm
35	19.1	18	67	50	84	56
35	22.1	18	67	50	84	56
35	22.1	18	67	75	109	58
35	28.1	18	85	85	120	70
45	28.1	18	85	85	120	70

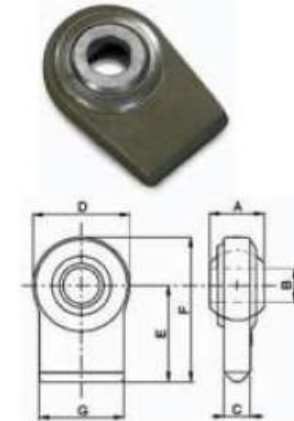

Top Link Ball Ends

A mm	B mm	C mm	D mm	E mm
60	60	44	19.50	34
75	63	51	22.50	38
85	70	51	25.40	48
53	48	30	19	25
90	85	51	32	38
83	65	55	29	50



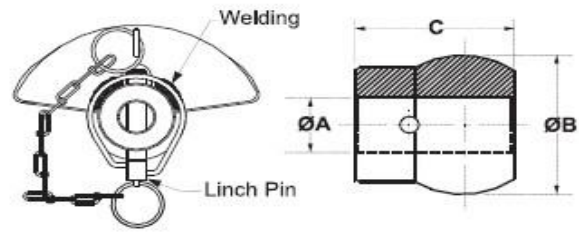

Guided Cone Balls

Dia. ØA (mm)	Dia. ØB (mm)	Dim. C (mm)
28.4	56	69
37.6	56	68
28.4	64	72
37	64	72

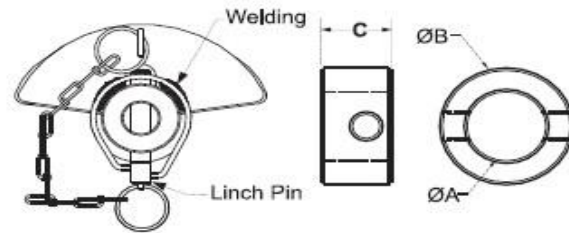

Guided Cone Bush

Dia. ØA (mm)	Dia. ØB (mm)	Dim. C (mm)
28.4	47	25
37.7	47	25

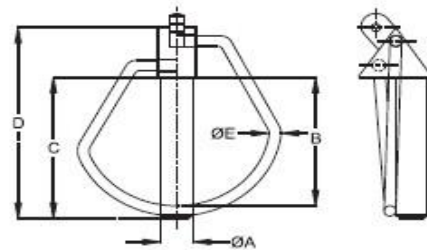

Linch Pins - Forged

Dia. ØA (mm)	Dim. B (mm)	Dim. C (mm)	Dim. D (mm)	Dia. ØE (mm)
11	48	52	70	4
15	48	60	82	4

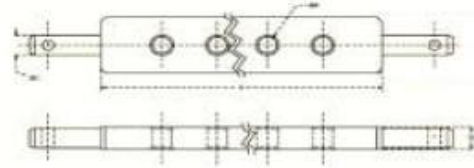

Draw Bars (76x32)

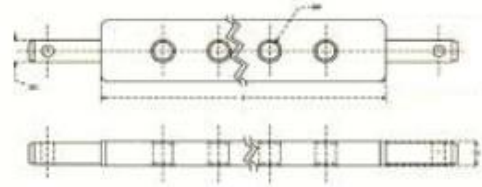
No. of Holes	Dim. A (mm)	Dim. B (mm)	Dim. C (mm)	Dia. ØD (mm)	Dia. ØE (mm)	Dim. F (mm)	Dim. G (mm)
5	861	60.5	740	28.4	27	140	115
6	800	58	684	28.4	20	104.5	95
7	750	55	640	28	25.5	80	80
7	876	50	776	28	28	100	96
7	890	64	762	28	29	126	85
7	890	55	780	28	28	124	88.6
7	925	50	825	28.4	25	172.5	80
7	930	55	820	28	28	110	100
7	930	55	820	28	26	85	109
7	932	62	807	28	26	49.5	86.2
7	940	60	820	28.4	28.5	152	86
7	940	55	830	28	30(2), 26(5)	85	110
7	940	55	830	28	26	85	110
7	981	60	861	28.4	28.5	154.5	92
9	800	70	660	28	28.4	70	65
9	910	55	800	28	25.5	80	80
9	945	60	825	28	22	92.5	80
9	945	60	825	28	33	92.5	80
9	962	51	860	28.5	33	110	80
9	980	55	870	28	25.5	87	87
11	825	55	715	28	22	87.5	65
11	932	60	812	28	28	86	64
11	933	55	823	28	22	86.5	65
11	933	60	813	28	28.5	81.5	65
11	960	55	850	28	26	100	65
11	960	55	850	28	22	100	65
11	960	62	836	28	28	78	68
13	932	60	812	28	19	76	55
13	940	60	820	28	19	76	55.6
13	940	60	820	28	22.4	76	55.6

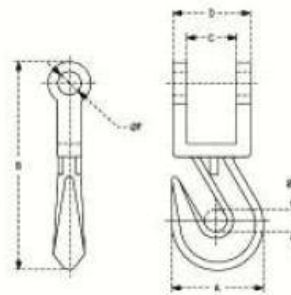

Draw Bars (80x40)

Item Code	No. of Holes	Dim. A (mm)	Dim. B (mm)	Dim. C (mm)	Dia. ØD (mm)	Dia. ØE (mm)	Dim. F (mm)	Dim. G (mm)
DB-851	3	770	56	658	28.5	26.5	164.5	164.5
DB-852	3	960	55	850	28	28.5	212.5	141.5
DB-853	5	1000	60	880	28	28	160	140
DB-854	5	1084	60	964	28.5	26	202	140
DB-855	6	890	63	764	28	28	132	100
DB-856	7	862	60	742	28.5	26	122	83
DB-857	7	930	55	820	28	28.5	102.5	102.5
DB-858	7	934	57	820	28	28	110	100
DB-859	7	940	60	820	28.5	26	125	95
DB-860	7	1085	60	965	36	33	152.5	110
DB-861	7	1094	65	946	36	32	152	110



Draw Bar Hook

Dim. A (mm)	Dim. B (mm)	Dim. C (mm)	Dia. D (mm)	Dia. E (mm)	Dim. F (mm)	Working Load Limit (Kg.)
90	190	40	69	19	19	4300



Top Link Pins

Dim. ØA (mm)	Dim. ØB (mm)	Dim. ØC (mm)	Dim. ØD (mm)
15.9	113	76	8.3
15.9	112.7	82.2	8.3
19	90	52	12
19	90	57	12
19	95	65	10
19	113	76	12
19	117	85	10
19	123	86	12
19	125	95	12
19	127	92	12
19	133	95	12
19	135	102.5	8.5
19	135	105	10
19	138	103	12
19	150	116	12
19	155	125	10
19	164	127	12
25	132	95	12
25	136	105	11
25	141	105	12
25	145	110	11
25	156	125	11
25	165	126	12
25	180	136	12
25	178	145	11
25.4	123	86	12
25.4	135	95	12
25.4	148	110	12
25.4	154	116	12
25.4	180	142	12

Dim. ØA (mm)	Dim. ØB (mm)	Dim. ØC (mm)	Dim. ØD (mm)
28	151	103	12
19	175	145	10
19	197	165	10
20	117	83	12
22	78	39	12
22	114	76	12
22	114	78	8.3
22	118	85	11
22	132	94	12
22	136	105	12
22	140	110	12
22	158	125	11
22	190	149	12
22	178	145	11
22	221	184	12
25	115	76	12
25	136	85	11
28	156	125	12
28	165	130	12
28	178	145	12
28.6	133	95	12
28.6	197	159	12
31	165	125	12
31.7	165.1	118.7	12
32	152	105	12
32	154	105	12
32	165	125	12
32	175	136	12



Straight Clevises

Body Dia ØA (Inches)	Clevis Opening B (Inches)	Usable Length C (Inches)	Pin Dia ØD (Inches)
5/8"	7/8"	3-1/4"	1/2"
3/4"	1-5/16"	3-3/4"	5/8"
7/8"	1-5/16"	3-1/4"	3/4"
7/8"	1-5/16"	4-1/4"	3/4"
15/16"	1-7/16"	4-5/8"	7/8"
1"	2-1/8"		1"

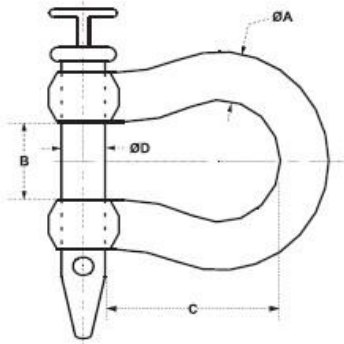

Twisted Clevises

Body Dia ØA (Inches)	Clevis Opening B (Inches)	Usable Length C (Inches)	Pin Dia ØD (Inches)
5/8"	7/8"	3"	1/2"
3/4"	1-5/16"	3-1/2"	5/8"
7/8"	1-5/16"	3"	3/4"
7/8"	1-5/16"	3-7/8"	3/4"
15/16"	1-7/16"	4-1/4"	7/8"
1"	2-1/8"	5"	1"

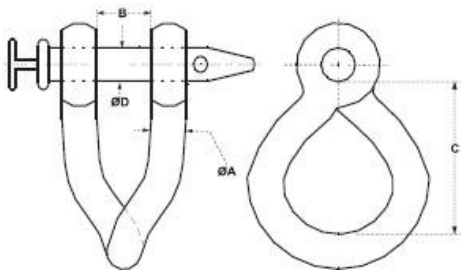

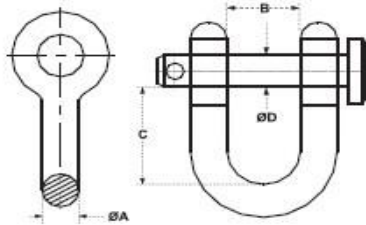

Utility Clevises

Body Dia ØA (Inches)	Clevis Opening B (Inches)	Usable Length C (Inches)	Pin Dia ØD (Inches)
1/4"	15/32"	7/8"	5/16"
5/16"	17/32"	1"	3/8"
3/8"	21/32"	1-1/4"	7/16"
7/16"	23/32"	1-1/2"	1/2"
1/2"	13/16"	1-11/16"	5/8"
5/8"	1-1/16"	2"	3/4"

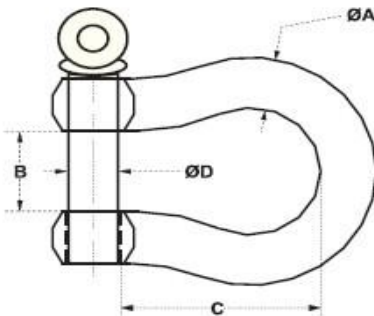

Farm Clevises

Body Dia ØA (Inches)	Clevis Opening B (Inches)	Usable Length C (Inches)	Pin Dia ØD (Inches)
1/4"	15/32"	1-1/8"	5/16"
5/16"	17/32"	1-1/4"	3/8"
3/8"	23/32"	1-7/16"	7/16"
7/16"	3/4"	1-11/16"	1/2"
1/2"	13/16"	1-15/16"	5/8"
5/8"	1-1/16"	2-1/2"	3/4"
3/4"	1-1/4"	3"	7/8"
7/8"	1-7/16"	3-1/4"	1"
1"	1-11/16"	3-3/4"	1-1/8"
1-1/8"	1-13/16"	4-1/4"	1-1/4"
1-1/4"	2"	4-1/2"	1-3/8"



THREE POINT ADAPTOR



HOOK

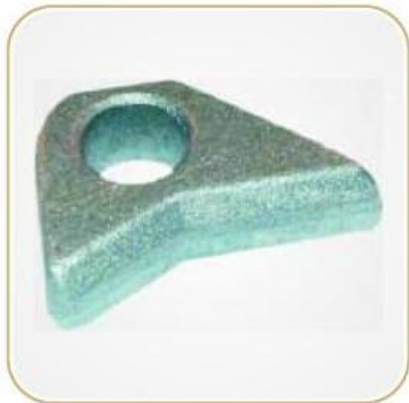

EYE



LOADER BRACKETS



THREE POINT HITCH



3 POINT HITCH TOW FRAME

CONTACT INFORMATION

Invicta India Pvt. Ltd.
N-258/B GK-1
New Delhi
India

REX Consolidated
80 DLF Industrial Area Phase 1
Faridabad Haryana-121003
India

© Copyright 2016 Invicta India Pvt. Ltd.

All information and data stated in this Product Range document has been compiled with utmost care. Nevertheless, Invicta accepts no liability for any errors, omissions or other inaccuracies contained herein. Subject to change without notice. Reprinting or reproduction, in whole or in part, including of photographs, illustrations or graphics, is not permitted without the prior written consent of Invicta India Pvt. Ltd.. We reserve all rights in connection with this document.

Any similarity or resemblance is unintended and is merely a coincidence.

The vehicle applications cited in this Product Range document may possibly be valid only up to the date printed on the last page of the document. All references made in this Product Range document to the item numbers of vehicle manufacturers and/or competitors are provided for the purpose of comparison only. Such information is not allowed to be used in invoices issued to vehicle owners.

For enquiries, please email us : rahul@invictaindia.com